

Amana® 30" (76.2 cm) Freestanding Gas Range

PRODUCT MODEL NUMBERS

AGR5330BA

Electrical Requirements

A 120 volt, 60 Hz., AC only, 15-amp fused, electrical circuit is required. A time-delay fuse or circuit breaker is also recommended. It is recommended that a separate circuit serving only this range be provided.

- This range is equipped with a power supply cord having a 3 prong ground plug. To minimize possible shock hazard the cord must be plugged into a grounded 3 prong outlet.

Gas Supply Requirements

Type of gas

Natural gas:

- This range is factory set for use with Natural gas. See "Gas Conversions" section. The model/serial rating plate located on the oven frame behind the top left side of the oven door has information on the types of gas that can be used. If the types of gas listed do not include the type of gas available, check with the local gas supplier.

LP gas conversion:

Conversion must be done by a qualified service technician. No attempt shall be made to convert the appliance from the gas specified on the model/serial rating plate for use with a different gas without consulting the serving gas supplier. See "Gas Conversions" section.

Gas Supply Line

- Provide a gas supply line of $\frac{3}{4}$ " (1.9 cm) rigid pipe to the range location. A smaller size pipe on longer runs may result in insufficient gas supply. With LP gas, piping or tubing size can be $\frac{1}{2}$ " (1.3 cm) minimum. Usually, LP gas suppliers determine the size and materials used in the system.

NOTE: Pipe-joint compounds that resist the action of LP gas must be used. Do not use TEFLON® tape.

Flexible metal appliance connector:

- If local codes permit, a new CSA design-certified, 4 to 5 ft (122 to 152.4 cm) long, $\frac{1}{2}$ " (1.3 cm) or $\frac{3}{4}$ " (1.9 cm) I.D., flexible metal appliance



connector may be used for connecting range to the gas supply line.

- A $\frac{1}{2}$ " (1.3 cm) male pipe thread is needed for connection to the female pipe threads of the inlet to the appliance pressure regulator.
- Do not kink or damage the flexible metal tubing when moving the range.
- Must include a shutoff valve:
The supply line must be equipped with a manual shutoff valve. This valve should be located in the same room but external to the range opening, such as an adjacent cabinet. It should be in a location that allows ease of opening and closing. Do not block access to shutoff valve. The valve is for turning on or shutting off gas to the range.

A. Gas supply line

B. Shutoff valve "open" position

C. To range

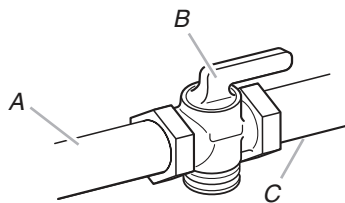

®TEFLON is a registered trademark of E.I. Du Pont De Nemours and Company.

PRODUCT DIMENSIONS

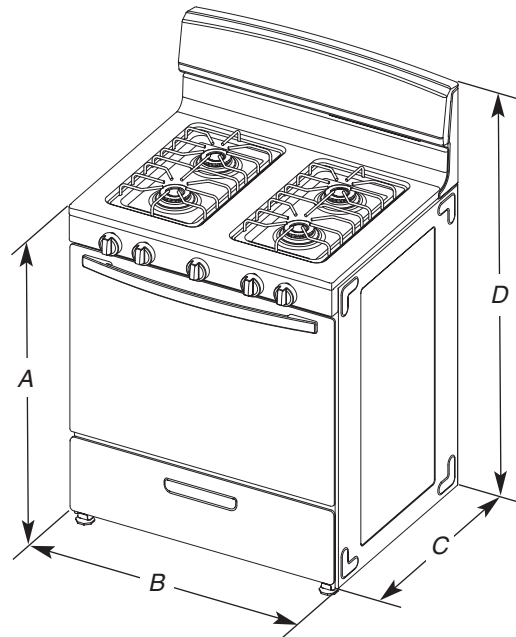

A. 36" (91.4 cm)

B. 29 $\frac{7}{8}$ " (75.9 cm)

C. 24 $\frac{1}{4}$ " (61.6 cm)

D. 46 $\frac{1}{4}$ " (117.5 cm)

IMPORTANT: Range must be level after installation. Follow the instructions in the "Level Range" section. Using the cooktop as a reference for leveling the range is not recommended.

CABINET OPENING DIMENSIONS

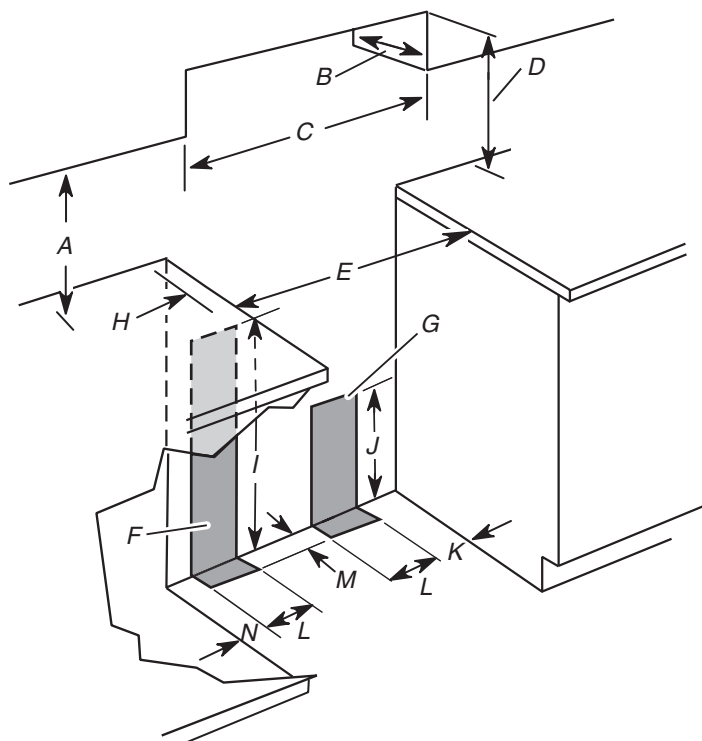

Cabinet opening dimensions shown are for 25" (64.0 cm) countertop depth, 24" (61.0 cm) base cabinet depth and 36" (91.4 cm) countertop height.

If the cabinet depth is greater than 24" (61.0 cm), oven frame must extend beyond cabinet fronts by ½" (1.3 cm) minimum.

IMPORTANT: If installing a range hood or microwave hood combination above the range, follow the range hood or microwave hood combination installation instructions for dimensional clearances above the cooktop surface.

- A. 18" (45.7 cm) min. clearance upper side cabinet to countertop
- B. 13" (33.0 cm) max. upper cabinet depth
- C. 30" (76.2 cm) min. cabinet opening width
- D. For minimum clearance to top of cooktop, see NOTE*.
- E. 30 ½" (76.5 cm) min. opening width
- F. This shaded area recommended for installation of electrical outlet.
- G. This shaded area recommended for installation of rigid gas pipe.
- H. 2" (5.1 cm) min. countertop space to side wall or other combustible material
- I. 24" (61.0 cm)
- J. 10" (25.4 cm)
- K. 8" (20.3 cm)
- L. 5" (12.7 cm)
- M. 2" (5.1 cm)
- N. 3" (7.6 cm)

*NOTE: 24" (61.0 cm) minimum when bottom of wood or metal cabinet is covered by not less than ¼" (0.64 cm) flame retardant millboard covered with not less than No. 28 MSG sheet steel, 0.015" (0.4 mm) stainless steel, 0.024" (0.6 mm) aluminum or 0.020" (0.5 mm) copper.

30" (76.2 cm) minimum clearance between the top of the cooking platform and the bottom of an uncovered wood or metal cabinet.