



Model Type B Gas Vent is used for venting all Category 1 listed gas appliances having draft hoods and other appliances listed to be used with Type B Gas Vent. For more information on venting unlisted gas appliances or appliances burning solid or liquid fuels, request our All-Fuel Chimney catalog.

Certification & Applications



AmeriVent is a pioneer in the development and simplification of effective venting products since 1951, AmeriVent components are crafted for today's building and appliance requirements. For any Type B gas venting, you will find AmeriVent has the most complete line of pipe and accessories.

One of the fire safety features of double-wall Type B gas vent is that its outer wall, insulated by the airspace beneath it requires only 1" clearance to combustible material in the structure. AmeriVent is a complete gas venting system, from draft hood connectors to termination caps. Whatever your gas venting needs (from 3" to 30" pipe diameters in 7 different pipe lengths, from single to multi-appliance hook-ups) you can create almost any system from our more than 350 coordinated parts. Featuring Snap-Lock joints that are quick and easy to connect and disconnect, the AmeriVent Type B gas vent system is lightweight with no sacrifice in strength, and is available in large sizes, adjustable components, and multi-story Type BW venting installation.

Product Description

The Type B designation is assigned to gas venting systems that meet the safety requirements of Underwriters Laboratories, Inc. The AmeriVent all-metal, double-wall gas vent is listed as Type B by UL and is approved for residential and commercial applications such as Category 1 water heaters, boilers, furnaces, space heaters, or wall heaters. UL-approved Type B gas vent products form a continuous passageway from an approved gas appliance to the termination of the vent above the roof of the structure.



Locking Tab
3" through 6"

Specifications and Dimensions

	Pipe Sizes	Pipe Lengths
	3", 4", 5" 6", 7", 8"	6", 12", 18", 24", 3', 4', 5' (except 8" size)
	9", 10", 12", 14", 16", 18", 20", 22", 24", 26", 28", 30"	12", 18", 24", 3'
	Pipe Sizes	Pipe Lengths
Oval	4", 5"	6", 12", 18", 24", 3', 4', 5'
	6"	6", 12", 18", 24", 3'
Maximum Height	Unlimited if properly supported	
Insulation	½ BTU per hour per square foot per degree F temperature differential (U factor = 0.5)	
Approved, Accepted, or Listed by	AGA, NFPA, HUD, NBC, UBC Underwriters Laboratories, Inc. to UL441 test standard	
How to Specify	Gas vents shall be UL-listed AmeriVent Gas Vent or equal installed in accordance with terms of the UL-listing and the manufacturer's published instructions.	

The AmeriVent Type B Quick Disconnect System

To Connect: Snap-lock pipe and fittings together

To Disengage the Locking Tab: Align the seams and pull apart

Locking Tab: To ensure a secure fit, push in the locking tab to lock the pipes together

Engagement: Snap-lock joints overlap - to calculate height deduct 1" for each joint

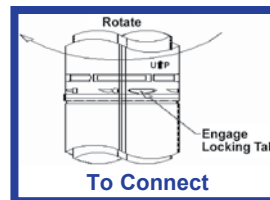

To Connect

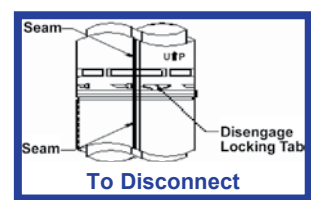

To Disconnect



GAS VENT TABLES - ROUND AND OVAL

TERMINATION HEIGHT TABLE

AmeriVent caps in 3" through 12" sizes may be installed in accordance with the Gas Vent Termination Table if the vent is at least 8' from any vertical wall. For installation of caps 14" and larger, or for caps that are less than 8' from a vertical wall, the cap is to be located no less than 2' above the highest point where the vent passes through the roof and at least 2' higher than any portion of a building within 10'.

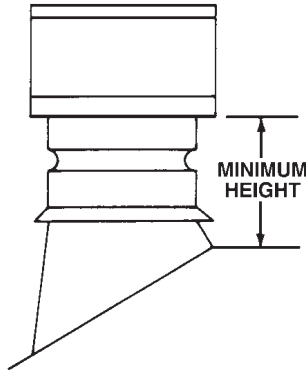

ROOF PITCH		MINIMUM HEIGHT
Flat	to 7/12	1 ft
Over	7/12 to 8/12	1 1/2 ft
Over	8/12 to 9/12	2 ft
Over	9/12 to 10/12	2 1/2 ft
Over	10/12 to 11/12	3 1/4 ft
Over	11/12 to 12/12	4 ft
Over	12/12 to 14/12	5 ft
Over	14/12 to 16/12	6 ft
Over	16/12 to 18/12	7 ft
Over	18/12 to 20/12	7 1/2 ft
Over	20/12 to 21/12	8 ft

OFFSET TABLE

This table is used to determine the offset produced by two AmeriVent 45° adjustable elbows set at the maximum angle of 45°. Also shown are the offsets produced by introducing various lengths of AmeriVent between the two elbows.

Maximum Offset in Inches

VENT SIZE	(2) 45° ELBOWS	LENGTH						
		(1) 6"	(1) 12"	(1) 18"	(1) 24"	(1) 3'	(1) 4'	(1) 5'
3	3 1/4"	6 3/4"	11"	15 1/4"	19 1/2"	28"	36 1/2"	45"
4	3 1/2"	7"	11 1/4"	15 1/2"	19 3/4"	28 1/4"	36 3/4"	45 1/4"
5	4 1/4"	7 3/4"	12"	16 1/4"	20"	29"	37 1/2"	46"
6	4 1/2"	8"	12 1/4"	16 1/2"	20 3/4"	29 1/4"	37 3/4"	46 1/4"
7	5"	8 1/2"	12 3/4"	17"	21 1/4"	29 3/4"	38 1/4"	46 3/4"
8	5 1/2"	9"	13 1/4"	17 1/2"	21 3/4"	30 1/4"		47 1/4"
9	6"		13 3/4"	18"	22 1/4"	30 3/4"		
10	7 1/4"		15"	19 1/4"	23 1/2"	32"		
12	7 1/4"		15"	19 1/4"	23 1/2"	32"		
14	8 1/2"		16 1/4"	20 1/2"	24 3/4"	33 1/4"		
16	9 1/4"		17"	21 1/4"	25 1/2"	34"		
18	10"		17 3/4"	22"	26 1/4"	34 3/4"		
20	10 1/4"		18"	22 1/4"	26 1/2"	35"		
22	10 1/4"		18"	22 1/4"	26 1/2"	35"		
24	11 1/4"		19"	23 1/4"	27 1/2"	36"		
26	12"		19 3/4"	24"	28 1/4"	36 3/4"		
28	12 3/4"		20 1/2"	24 3/4"	29"	37 1/2"		
30	13 1/2"		21 1/4"	25 1/2"	29 3/4"	38 1/4"		

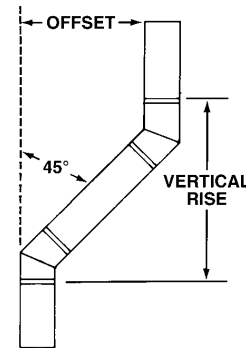

Note: The vertical rise can also be closely estimated by adding one "A" and one "B" dimension to Maximum Offset figures. (See dimensions of Round Adjustable 45° Elbows.)



GAS VENT TABLES - ROUND AND OVAL

SYSTEM DESIGN AND INSTALLATION GUIDES

The following installation guidelines have been prepared to assist you in your particular application and in installing a vent correctly.

Before laying out a gas vent system for any gas appliance, the installer should first consult the local code and the appliance manufacturer's installation requirements. Only then should you pick your components and design your vent system.

AmeriVent offers a wide range of round and oval pipe sizes and adjustable components to provide maximum design flexibility. All three basic gas vent installations (as defined by Underwriters Laboratories, Inc.) can be constructed using AmeriVent. These three are:

TYPE B

AmeriVent (Sizes 3" through 30" round and sizes 4", 5", and 6" oval) may be installed with 1" minimum clearance to combustibles.

TYPE BW

4" oval AmeriVent (when installed in 2 x 4 stud wall with recessed heater) requires clearances as determined by use of 40HD hold-down plate, 40PS ceiling plate spacers, and 40FS firestop spacers.

TYPE B 2 X 4

4" and 5" oval AmeriVent (when installed in 2 x 4 stud wall with other than recessed heater) requires clearance as determined by use of 40FS or 50FS firestop spacers at each ceiling level.

To graphically illustrate the use of AmeriVent components in typical installations, we offer the diagrams on the next page. Here you'll see just about every AmeriVent part and how each contributes to a complete installation.

To guide you in these and other installations, the following general rules should be followed.

1. Provide an adequate air supply. Remember, you must meet local code minimum requirements for both combustion air and draft hood dilution air.
2. Attach vent to appliances draft hood with sheet metal screws and terminate the vent at least 5' above the draft hood. For wall furnaces, vents must terminate at least 12' from bottom of heater. See Gas Vent Termination Table for required height above roof.
3. One gas vent may serve more than one gas appliance. Prudent advanced planning (see diagrams) can save you time.
4. Keep offsets and lengths of laterals to a minimum to reduce vent resistance.
5. Strap the vent securely in position, always maintaining at least 1" clearance to combustibles. Firestops should be used where vents pass through floors, walls, or ceilings. (See Product Description section for Round Wall Thimble, Vent Collar, Bucket Support, Support Plate, Firestop Support Plate, and Oval Firestop Spacer.)
6. The vent termination must be securely guyed or braced if it extends more than 5' above the roof.
7. For longer-lasting durability and better appearance, all vents exposed to the weather (except caps) should be painted.
8. Excessive exterior vents reduce venting action; therefore, such installations are not recommended.

For additional guidance in proper sizing of Type B Gas Vent refer to the **Venting Guidelines for Category I Gas Appliances** (Available on www.ameri-vent.com)



TYPE B GAS VENT ~ ROUND

ELBOWS (CONTINUED)

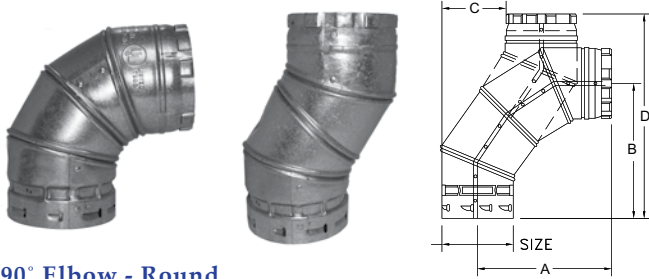

90° Elbow - Round

- Adjusts from 0° to 90° easily in order to clear rafters or ceiling joists
- Constructed of four sections for smoother bends and less resistance

PART #	SIZE	A	B	C	D
3EAL	3"	4 1/2"	5 1/4"	1 1/2"	8"
4EAL	4"	5"	5 1/2"	1 1/2"	8 3/4"
5EAL	5"	5 1/2"	6"	2 1/4"	9 1/4"
6EAL	6"	6 1/2"	7"	2 1/2"	10 1/4"
7RAL	7"	7 3/4"	8"	3"	12 1/4"
8RAL	8"	8 3/4"	9"	3 1/4"	13"

TEE COMPONENTS

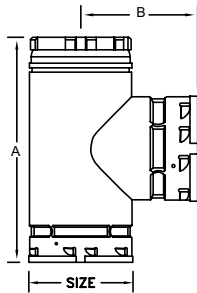

Tee - Round

- Transitions a system from horizontal to vertical orientation
- Branch and trunk diameters of the standard tee are the same size
- For smaller branch sizes, use a reducing tee up to 6" size
- For larger sizes, use an increaser with a standard tee

PART #	SIZE	A	B
3ET	3"	7 1/8"	4 1/8"
4ET	4"	8 7/8"	4 5/8"
5ET	5"	10"	5 1/4"
6ET	6"	11 1/2"	5 3/4"
7RT	7"	13"	6 1/2"
8RT	8"	14"	6 7/8"
9RT	9"	15"	7 3/4"
10RT	10"	16"	8 1/16"
12RT	12"	17 9/16"	9 3/4"
14RT	14"	24"	11 3/4"
16RT	16"	26"	13"
18RT	18"	28 1/2"	14 1/4"
20RT	20"	30"	15 1/2"
22RT	22"	33"	16 3/4"
24RT	24"	36"	18"
26RT	26"	38"	19"
28RT	28"	40"	20"
30RT	30"	42"	21"

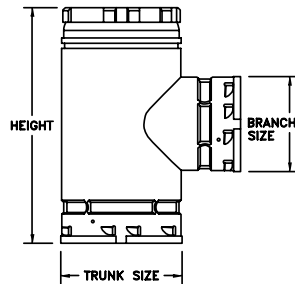

Reducing Tee - Round

- Features a branch with a smaller diameter than its trunk size, and provides a convenient connection of the furnace and water heater to a common vent

PART #	TRUNK SIZE	BRANCH SIZE	HEIGHT
4ET-3	4"	3"	8 7/8"
5ET-3	5"	3"	10"
5ET-4	5"	4"	10"
6ET-3	6"	3"	11 1/2"
6ET-4	6"	4"	11 1/2"
6ET-5	6"	5"	11 1/2"