

American Standard

MANUAL FLUSH VALVE 1.0 GPF

Exposed Flushometer
for Top Spud Urinals

MODEL NUMBERS

6045.101

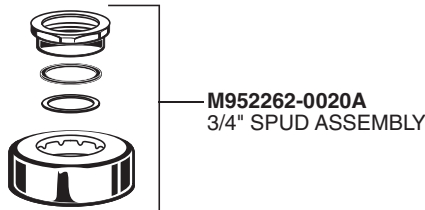
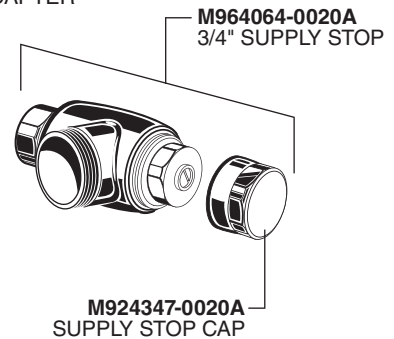
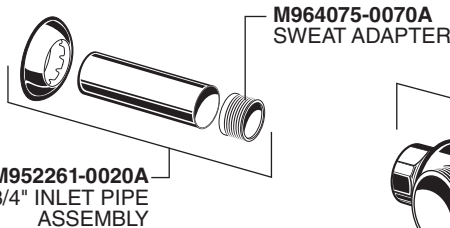
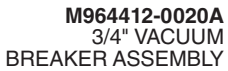
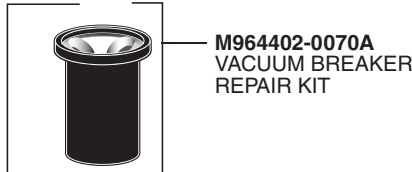
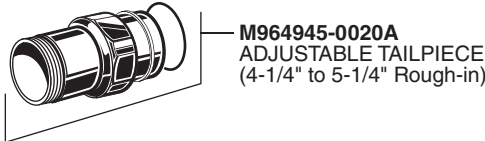
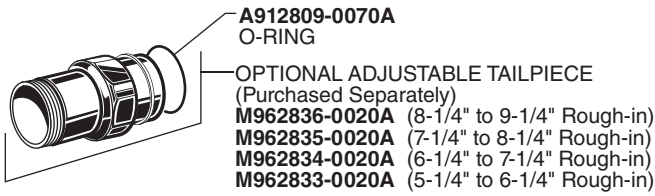
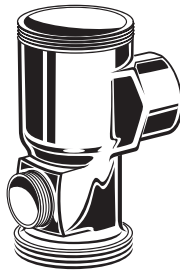
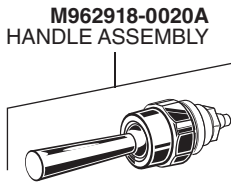
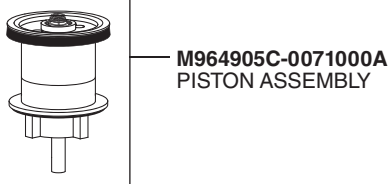

PART OF LIXIL



HOT LINE FOR HELP

For toll-free information and answers to your questions, call:

(844) CRT-TEAM / (844) 278-8326
Weekdays 8:00 a.m. to 6:00 p.m. EST
IN MEXICO 01-800-839-1200

IN CANADA 1-800-387-0369 (TORONTO 1-905-306-1093)
Weekdays 8:00 a.m. to 7:00 p.m. EST

Product names listed herein are trademarks of AS America, Inc. ©2017

To learn more about American Standard Selectronic® Products visit our website at:
www.americanstandard-us.com or e-mail us at: CRTTEAM@americanstandard.com