

1300 SERIES 3-CONE FACE DIFFUSER

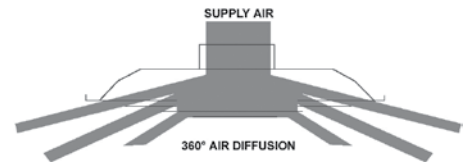

- Fits 24" x 24" T-Bar Grid
- Fixed 2" collars attached
- R4.2 molded insulation back 1300 INS
- R6 molded insulation back 1300 INSL R6
- Bright White finish

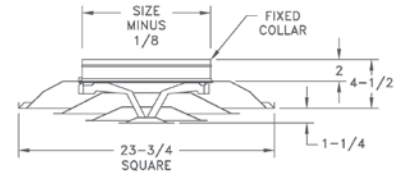

Model	Material	Damper
1300	Steel	none
1300 INS	Steel	none
1300 INSL R6	Steel	none

1300U R6 3- CONE FACE DIFFUSER

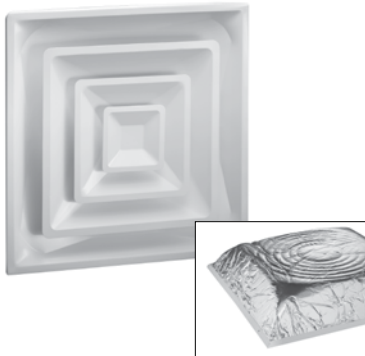

- Provides high air volume delivery
- 360° air diffusion
- Fixed core
- Formed back panel
- Insulation prescored to accommodate collar size desired
- R6 molded fiberglass back use 805RC with 805PP
- Utilizes butterfly damper (800DO Series) inserted in collar
- 1302U R6 uses spin-in or tab collar for duct connection
- Bright White finish

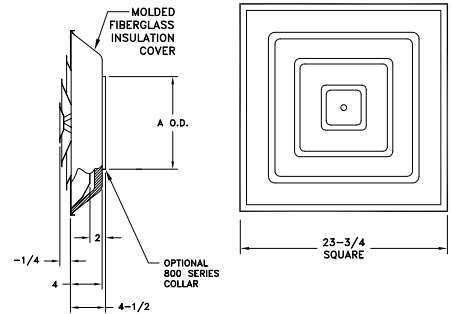

Model	Material	Damper
1300U R6	Steel	none

1301 SERIES 3-CONE FACE DIFFUSER W/ DAMPER

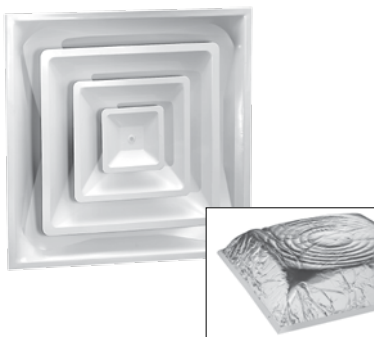

- Fits 24" x 24" T-Bar Grid
- Fixed 2" collars attached and butterfly damper
- R4.2 molded insulation back 1301 INS
- R6 molded insulation back 1301 INSL R6
- Bright White finish

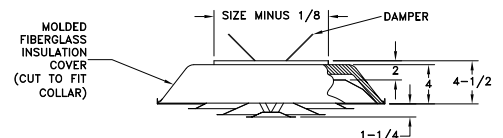
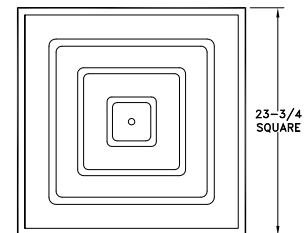

Model	Material	Damper
1301	Steel	Butterfly
1301 INS	Steel	Butterfly
1301 INSL R6	Steel	Butterfly